

Pos.	Artikelbeschreibung	Description of item	Artikel Nr./Item No.
1	Scharnier z. Deckel	Hinge f. lid	020300096
1a	Scharnierangel	Hinge	020300097
1b	Feder-Set, links u. rechts	Spring-set, left and right	E02050005
1c			
1d	Rohr f. Scharnier	Tube f. hinge	Auf Anfr./On req.
1e	Inbussschraube M6	Socket screw M6	Auf Anfr./On req.
2	Deckel	Lid	0SMP012000
3	Ablaufsieb für Kochkessel	Drainage filter for cooking pot	296999
4	Verlängerung z. Deckelgriff	Lid handle extension	020200014
5	Griff z. Deckel	Handle f. lid	020200013
6	Einlaufbogen	Water inlet bow	030200072
7	Mischbatterie	Mixing battery	030200070
8	Druckanzeiger, kpl.	Pressure indicator, cpl.	0GRP140002
8a	Halterung f. Ventil/Druckanzeiger	Holder f. valve/pressure indicator	030300062
8b	Verlängerung 3/8 Zoll, L 50 mm	Extension 3/8", L 50 mm	010400058
8c	Reduzierstück	Reducer	Auf Anfr./On req.
8d	Manometer	Manometer	018606
8e	Sicherheitsventil 0,5 bar	Safety valve 0,5 bar	030300014
8f	Propfen 3/4 Zoll	Plug 3/4"	010400061
8g	O-Ring, D 28	O-ring, D 28	010500110
8h	Verlängerung 3/4 Zoll	Extension 3/4"	010400059
9	Fuß, 2 Zoll	Base, 2 "	020100020
10	Armatur, kpl. 2 Zoll	Armature, cpl. 2"	030200198
10a	Gehäuse z. Hahn	Tap body	Auf Anfr./On req.
10b	Hahn - Innenteil, konisch	Conical male	Auf Anfr./On req.
10c	Griff, thermisch-isoliert	Handle, termal-insulated	030200182
10d	Bolzen	Fixing pin	Auf Anfr./On req.
10e	Ring f. Ablasshahn	Washer for tap	Auf Anfr./On req.
10f	Mutter f. Ablasshahn	Nut for tap	Auf Anfr./On req.
10g	Mutter 2 Zoll	Nut 2 "	Auf Anfr./On req.
10h	Haltering	Fixing ring	Auf Anfr./On req.
10i	Dichtung, Teflon D 60 x 46 x 2	Gasket, Teflon D 60 x 46 x 2	Auf Anfr./On req.
11	Doppelnippel 2 Zoll	Double nipple 2"	010400006
12	Ring z. Ablasshahn 2 Zoll	Ring f. drain cock 2"	010200002
13	Kontrollhahn	Control cock	030200050

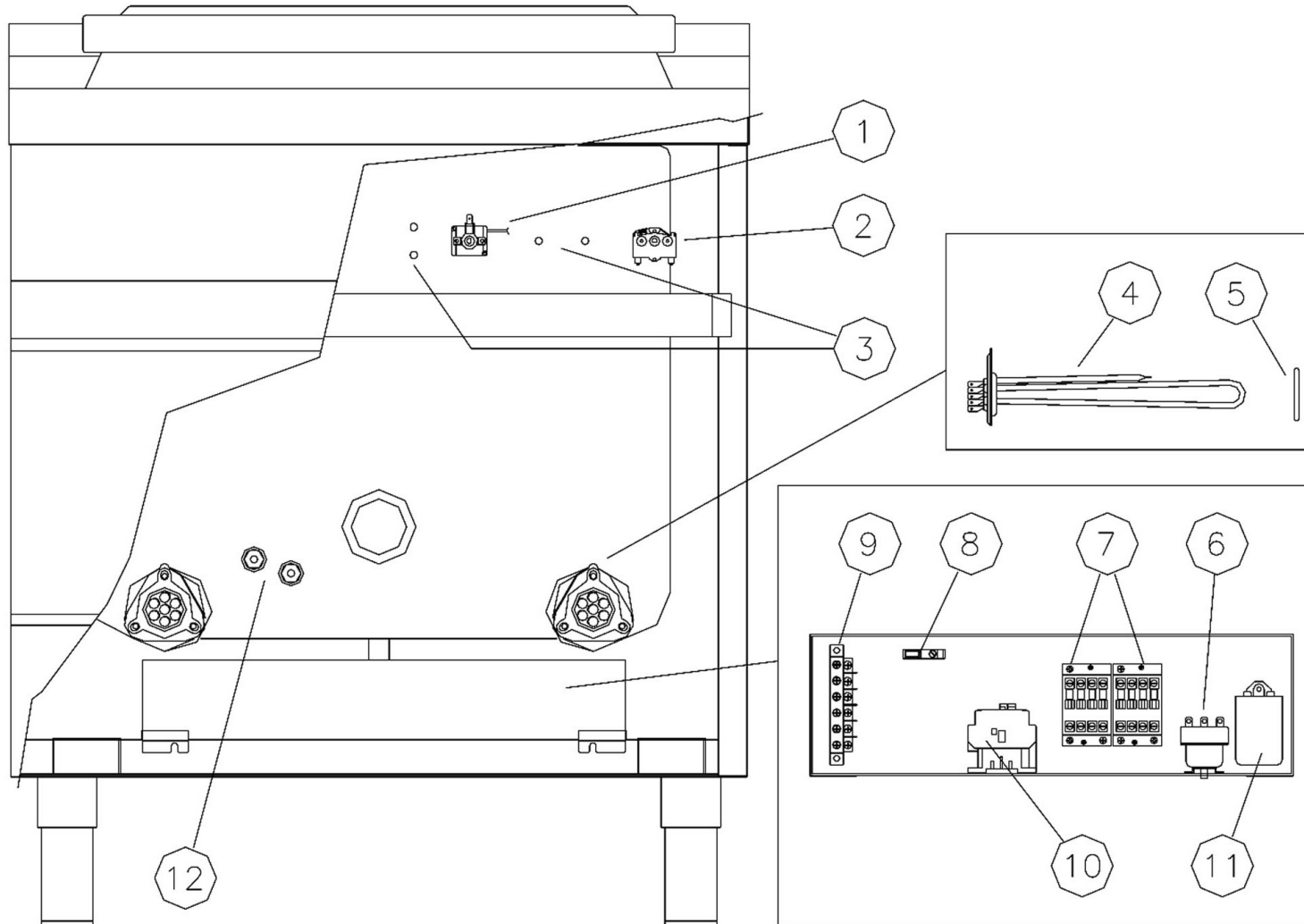

Kochkessel E113L
Kochkessel E145L
Artikel-Nr.: 280015/280016

Ersatzteilliste
21.08.2018



Pos.	Artikelbeschreibung	Description of item	Artikel Nr./Item No.
1	Knebel f. Thermostat, 30 - 100 °C	Knob f. thermostat, 30 - 100 °C	020200006
2	Knebel f. Voll-/Halbleistung	Knob f. full/half power	020200007
3	Kontrolllampe grün	Green indicator light	040200152
4	Kontrolllampe orange	Orange indicator light	040200150
5	Kontrolllampe rot, LED	Red indicator light, LED	0402000190
6	Kontrolllampe orange, LED	Orange indicator light, LED	0402000192



Kochkessel E113L
Kochkessel E145L
Artikel-Nr.: 280015/280016

Ersatzteilliste
21.08.2018

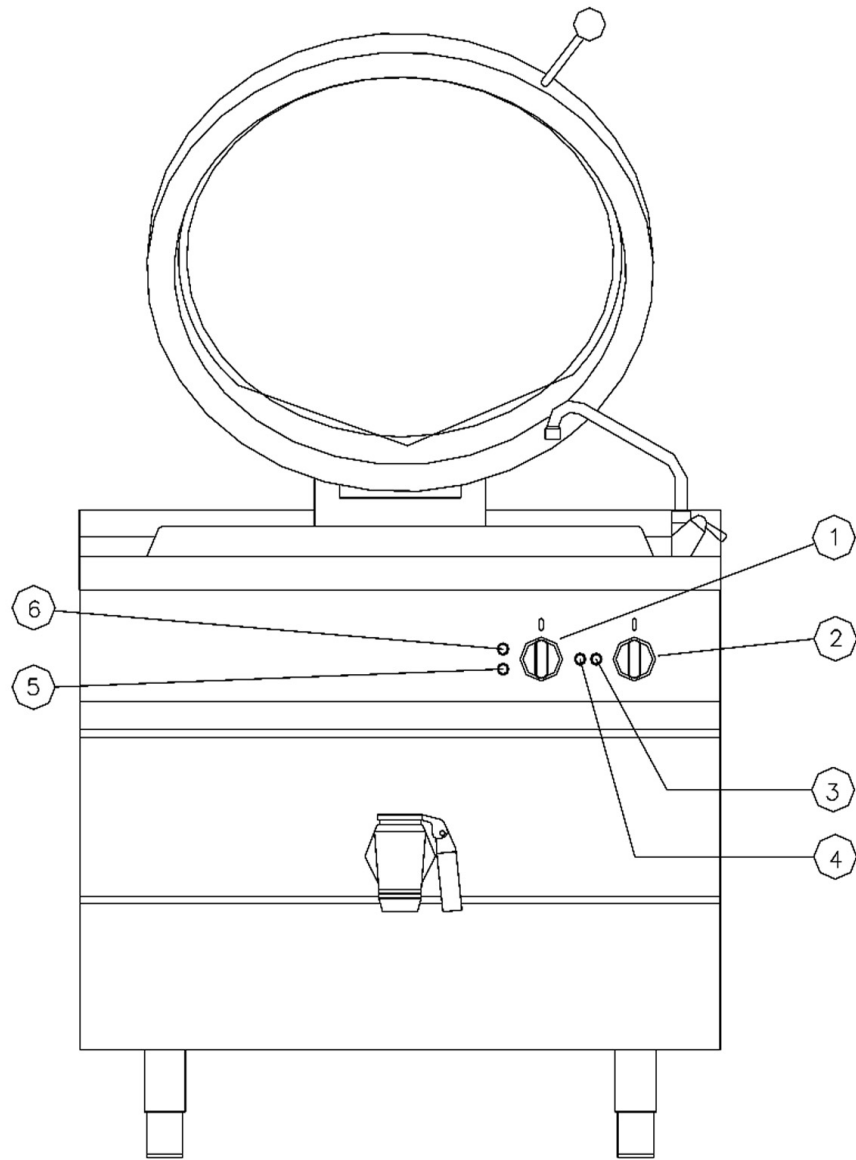

Pos.	Artikelbeschreibung	Description of item	Artikel Nr./Item No.
1	Thermostat	Thermostat	040100050
2	Nockenschalter	Change over switch	040100004
3	Neonleuchte	Neon lamp	Auf Anfr./On req.
4	Heizkörper, 8 kW, 230 V	Heating element, 8 kW, 230 V	E040400048
	Heizkörper, 9 kW	Heating element, 9 kW	040400038
5	O-Ring z. Heizkörper	O-ring f. heating element	010500100
6	Sicherheitsthermostat 180 °C	Safety thermostat 180 °C	040100044
7	Schütz 4P A9/25A	Contactator 4P A9/25A	040100023
8	Schmelzsicherung, 5 x 20, 3,15 A	Safety fuse, 5 x 20, 3,15 A	040200084
9	Anschlussklemme	Terminal clamp	06050577
10	Schütz 30A 4P AC1-230V/50HZ	Contactator 30A 4P AC1-230V/50HZ	040100024
11	Füllstandregulierung	Fill level regulation	040800054
12	Sonde	Probe	040800040



Kochkessel E113L
 Kochkessel E145L
 Artikel-Nr.: 280015/280016

Ersatzteilliste
 21.08.2018